

Mobile Printer
SM-T300DB SERIES

Hardware Manual



star 

Radio Equipment Information:

Informations relatives à l'équipement radioélectrique :

Radiogeräteinformationen:

Informatie over de radioapparatuur:

Informazioni sulle apparecchiature radio:

Información sobre equipos de radio:

Informações de equipamento de rádio:

Radyo Ekipmanı Bilgileri:

Πληροφορίες περί ραδιοεξοπλισμού:

Informacije o radijski opremi:

Informacije o radijskoj opremi:

Information vedr. radioustyr:

Radioaaltoja lähettävän laitteen tiedot:

Informasjon om radioustyr:

Information om radioutrustning:

Informacja o urządzeniach radiowych:

Informace o rádiovém vyzářování přístroje:

Rádióhullám-kibocsátási adatok:

Informácie o rádiovom zariadení:

Informații privind echipamentele radio:

Informācija par radio iekārtu:

Radijo ryšio įrangos informacija:

Raadioseadme teave:

Informazzjoni tat-Tagħmir tar-Radju:

Eolas faoi Threalamh Raidió:

2402 - 2480 MHz	max. 20 dBm (E.I.R.P.)
-----------------	------------------------

EU Declaration of Conformity

Konformitätserklärung
Déclaration de conformité
Declaración de conformidad
Dichiarazione di conformità
Verklaring van conformiteit
Izjava o skladnosti
Izjava o skladnosti
Prohlášení o shodě
Uyumluluk Beyanı
Megfelelőségi nyilatkozat
Overensstemmelseserklæring
Försäkran om överensstämmelse
Vaatumuksenmukaisuusvakuutus
Konformitetserklæring
Declaração de Conformidade
Δήλωση συμμόρφωσης
Deklaracja zgodności
Vyhlásenie o zhode
Vastavusdeklaratsioon
Atbilstības deklarācija
Atitikties deklaracija
Dikjarazzjoni ta' Konformità
Declarație de conformitate
Декларация за съответствие

https://download.starmicronics.com/manual/CE_DoC/WSP-i350_CE_DoC_Newest.pdf

Italia: l'uso pubblico e soggetto ad autorizzazione generale da parte del rispettivo provider di servizi.

Noorwegen: Gebruik van radioapparatuur is niet toegestaan in het geografische gebied binnen een straal van 20 km vanaf het centrum van Ny-Ålesund, Svalbard.

This statement will be applied only for the printers marketed in Europe.

UK Declaration of Conformity

https://download.starmicronics.com/manual/CE_DoC/WSP-i350_UK_DoC_Newest.pdf

FCC/IC Statement

https://download.starmicronics.com/manual/FCC/FCC_IC_Statement_Type6.pdf

Mexico Statement

LA OPERACIÓN DE ESTE DISPOSITIVO ESTA SUJETA A LAS SIGUIENTES CONDICIONES:

- a) Es posible que este equipo o dispositivo no cause interferencia perjudicial.
- b) Este equipo o dispositivo debe aceptar cualquier tipo de interferencia, incluyendo la que pueda causar su operación no deseada.

WARNING RF EXPLOSURE

A distance of at least 20 cm {7.87"} must be maintained at all times between the antenna of this product and people in the vicinity. May exert electromagnetic interference on, and cause malfunction of, cardiac pacemakers.

Trademark acknowledgments

SM-T300DB : Star Micronics Co., Ltd.

Notice

- All rights reserved. Reproduction of any part of this manual in any form whatsoever, without STAR's express permission is forbidden.
- The contents of this manual are subject to change without notice.
- All efforts have been made to ensure the accuracy of the contents of this manual at the time of going to press. However, should any errors be detected, STAR would greatly appreciate being informed of them.
- The above notwithstanding, STAR can assume no responsibility for any errors in this manual.
- All company and product names are trademarks or registered trademarks of their respective owners.

<https://www.star-m.jp/eng/trademarks.html>

Caution Symbol



Caution for burns: The print head may be hot.
Do not touch the print head. There is a risk of burns.



Caution for static electricity: Do not touch the print head as it may be damaged by static electricity accumulated in the human body.

Safety Precautions

Please be sure to read

To use this product in safety, please follow the precautions given below.

WARNING

- ✓ If you notice smoke, a strange smell, or a strange sound, turn off the power immediately, and remove the battery pack and battery charger. Then contact a Star Micronics dealer.
 - ✓ If any foreign material (metal scraps, water, or other fluid) enters the printer, immediately turn off the printer and remove the battery charger and/or battery pack. Then, contact your dealer for advice. Continued use of the printer could result in a fire.
 - ✓ Never attempt to repair the printer yourself. Also do not disassemble or modify the product.
Doing so could lead to injury, fire, or electric shock.
 - ✓ Do not touch the tear bar.
 - There is a tear bar inside the paper outlet slot. Not only should you not put your hand in the paper outlet slot while printing is in progress, never put your hand into the outlet even when printing is not in progress.
 - The printer cover can be opened when replacing the paper. However, since the tear bar is on the inside of the printer cover, be careful not to place your face or hands too close to the tear bar.
 - ✓ During and immediately after printing, the area around the thermal head is very hot.
Do not touch it, as you could be burned.
 - ✓ If any battery pack fluid gets on your skin or clothing, immediately wash the affected area with fresh water. Otherwise, skin damage may result.
 - ✓ The battery pack may be hot immediately after the product has been used.
-

■ Using the Printer

- ✓ Do not use any battery charger other than the provided charger.
If a battery charger other than the specified charger is used, there is the risk of electric shock or fire.
- ✓ Do not wire the cables in a way other than designated.
Doing so could result in a fire. It may also damage other connected devices.
- ✓ Some semiconductors can be damaged by static electricity.
Be sure to turn off the printer when inserting or removing the battery pack.
- ✓ Do not drop the printer or hit it against a hard object.
- ✓ Do not open the printer cover while the printer is printing.
- ✓ Before you open the printer cover, make sure that printing data is not being sent to the printer.
- ✓ Do not unplug or plug in a communication cable while the printer is printing or during communication.
- ✓ Do not touch a communication connector while the printer is printing.
- ✓ Turn off the printer when you are not using it.
- ✓ When the printer is used in a low temperature environment or when a PIN pad or other device that needs electricity is connected to the printer, the battery's performance will be diminished, and the amount of time that you can use the printer for may be reduced.
- ✓ Do not pull out paper while the printer cover is closed.
- ✓ The heating element and the driver IC of the thermal head are easily damaged. Do not touch them with metal objects, sandpaper, etc.
- ✓ Printing quality may suffer if the thermal head heating element becomes soiled by being touched with your hands. Do not touch the thermal head heating element.
- ✓ There is a risk of damage to the driver IC of the thermal head from static electricity.
Never directly touch the IC.
- ✓ Do not operate the printer if there is moisture on the front surface of the head from condensation, etc.

■ Thermal Paper Handling

- ✓ Only use thermal paper with the designated specifications.
The printing quality and working life of the thermal head cannot be guaranteed if any paper other than that recommended is used. In particular, paper containing [Na+, K+, Cl-] may drastically reduce the working life of the thermal head. Please exercise caution.
- ✓ Store the thermal paper in a cool, dry, dark location.
- ✓ Do not rub the thermal paper with a hard object.
- ✓ Do not leave the thermal paper in contact with plastic film, an eraser, or adhesive tape for a long period of time.
- ✓ Do not stack the thermal paper on fresh diazo copies or wet-type copies.
- ✓ Do not use chemical glue on the thermal paper.
- ✓ Do not use thermal paper that has been stored for a long period of time.

■ Operating Environment for the Printer

Before actually unpacking the printer, you should take a few minutes to think about where you plan to use it. Remember the following points when doing this.

- ✓ Do not use the printer in an environment in which it will be subject to strong shaking while it is printing.
- ✓ Be careful to ensure that the printer is not exposed to direct sunlight.
The appropriate environment for using the printer is described below.
Temperature: -10°C to 50°C
Humidity: 30 % RH to 80 % RH (no condensation)
- ✓ Do not place the printer near a copying machine or other device that produces a strong electromagnetic field.
- ✓ Keep the printer sufficiently removed from heaters and other sources of heat.
- ✓ Use the printer in a clean, low-humidity environment that is free from dust.
- ✓ Avoid using the printer in high-humidity rooms.
- ✓ We recommend that you unplug the printer from the power outlet whenever you do not plan to use it for long periods. Because of this, you should locate the printer so that the power outlet it is plugged into is nearby and easy to access.

■ Printer Maintenance

Please perform the following maintenance every 6 months.

- ✓ Thermal head
Dip a cotton swab in an alcohol solvent (ethanol, methanol, or isopropyl alcohol), and clean the heating area of the head.
- ✓ Platen
While turning the platen, use a soft, dry cloth to lightly rub the entire surface of the platen and remove any foreign objects.
- ✓ Paper storage unit and the surrounding area
Remove any dirt, dust, pieces of paper, etc., from the paper storage unit.
- ✓ Card reader
Regularly blow air onto the card reader to remove any dust from the card slot.

■ Using a Magnetic Card

- ✓ Do not bring magnets near the card, and do not store the card near a device that produces a magnetic field (such as a mobile phone, speaker, or TV).
If you do so, the data on the card may be deleted.
- ✓ Do not leave the card in a high-temperature environment (such as the dashboard of a car).
If you do so, the card may bend.
- ✓ Do not touch the card with dirty or wet hands. Also, do not attach adhesive tape or glue to the card.
Failing to follow the above precautions could cause the card to stop working properly.

Table of Contents

1. Product Overview	9
1.1 Printer & Accessories	10
1.2 External Appearance and Part Names	11
2. Setup	12
2.1 Battery Pack	12
2.1.1 Inserting into the Printer or the Battery Holder	12
2.1.2 Charging the Battery.....	13
2.2 Bluetooth.....	16
2.2.1 Pairing	16
2.3 Loading Paper.....	17
2.4 Belt Clip	19
2.4.1 Attaching to the Printer.....	19
2.4.2 Using the Belt Clip.....	19
3. Printer Features	20
3.1 Control Panel	20
3.1.1 Button.....	20
3.1.2 Panel Lamp	20
3.1.3 LCD	20
3.2 Self Test	21
3.2.1 Self Test Procedure	21
3.2.2 Printing the Bluetooth Device Name and the Bluetooth Device Address	21
3.3 Memory Switch Setting (By the buttons on the printer).....	22
3.4 HEX Dump Mode.....	28
3.5 Instruction for Auto Power Down(Sleep) Mode.....	29
3.6 Card Reading (Only for Model with Card Reader).....	29
4. Paper	30
4.1 Paper Specifications.....	30
4.2 Recommended Paper (Common thermal roll paper)	30
4.3 Printing Range	30
5. General Specifications	31
6. Version History	33

This manual supports the following firmware version.

Firmware Version:

Ver 4.2 or later

Refer to the appropriate hardware manual which supports the firmware version of your printer.
The firmware version can be confirmed by the self-test. ("3.2 Self Test" of Page 21)

1. Product Overview

This printer is perfect for mobile banking systems, retail, POS (point of sale) terminals and other forms of mobile computing.

► The characteristics of this printer are listed below:

- Pocket size (120 ×130.5 × 58.4 mm) <Model without Card Reader>
- Extremely light and mobile (424 g)
- Up to 31 hours of battery-powered operation (12 receipts per hour / Sleep setting after 1 minute)
- International Splash/Dust Proof "IP54" Certified
- 1.5m Drop Resistance (Tough Rubber Type Case Design)
*Our test procedure, Not guarantee
- Support High Quality Print Mode (Double-Stroke Mode)
- Very silent printing thru direct thermal printing method
- High speed (80 mm/sec, max.)
- Standard-equipped dual interface (RS-232C serial interface and Bluetooth Ver. 3.0 interface)
- Support for secure Bluetooth communications
Support for Bluetooth Security Mode 3 (PINs of up to 16 digits in length)
- Support Magnetic Stripe Reader <Model with Card Reader>
- Support Graphic LCD(128×32 dots) with Blue LED Backlight
- Belt Clip as a standard accessory
- Support text and graphic printing
- Bit-Image(Logo) Store Function "Use Logo Store Tool to store a logo."
- Drop-in design that makes it easy to load paper
- A printer cover that can be opened with the touch of a button
- Printer cover open sensor & Paper-out sensor
- Flow control : Software (XON/XOFF)
Note: Hardware flow control not supported in printer

1.1 Printer & Accessories

The printer is packaged with the following accessories.

If any of these accessories is broken or missing, please contact the dealer that you bought the product.

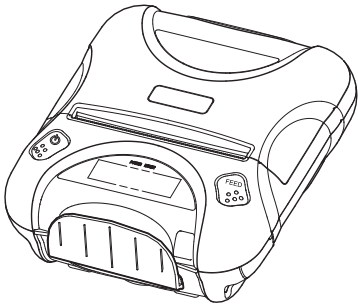

Printer

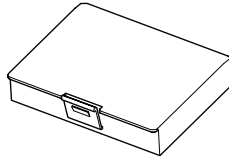

Battery Pack

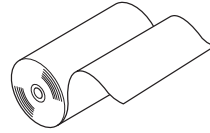

Printer paper sample



Belt Clip

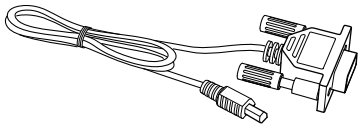

Serial Communication Cable

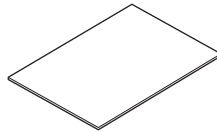

Safety Instruction Sheet

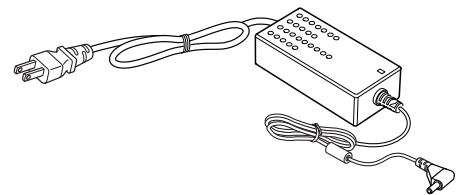

Battery Charger

► The optional items for this printer are listed below.

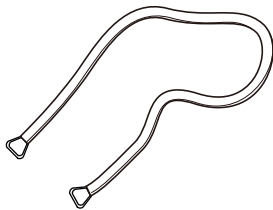

Shoulder Strap

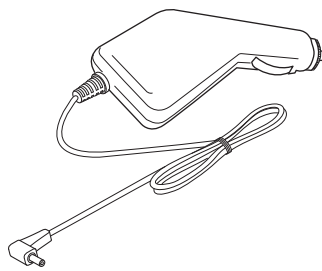

Car Charger

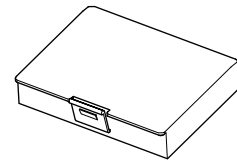

Extra Battery Pack

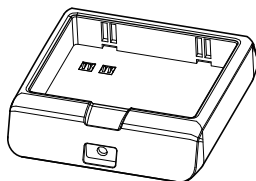

Battery Holder

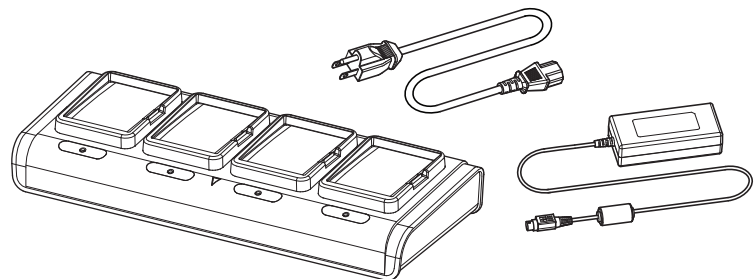

4 Unit Battery Charger (Special AC Adapter + 4 Unit Holder)

1.2 External Appearance and Part Names

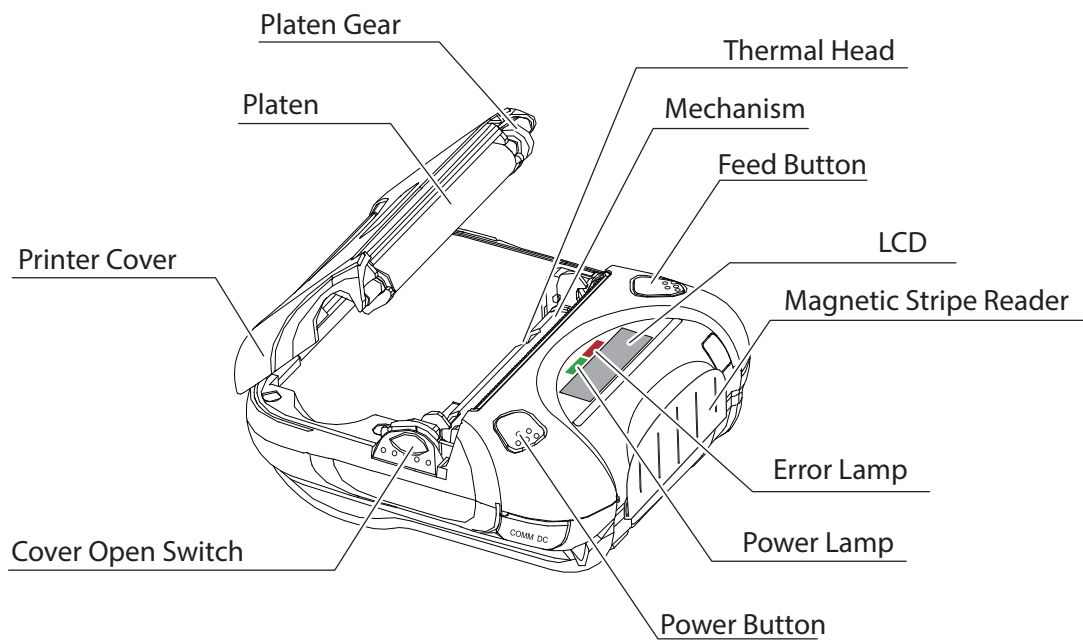

Note: Remove the films if you do not need them.

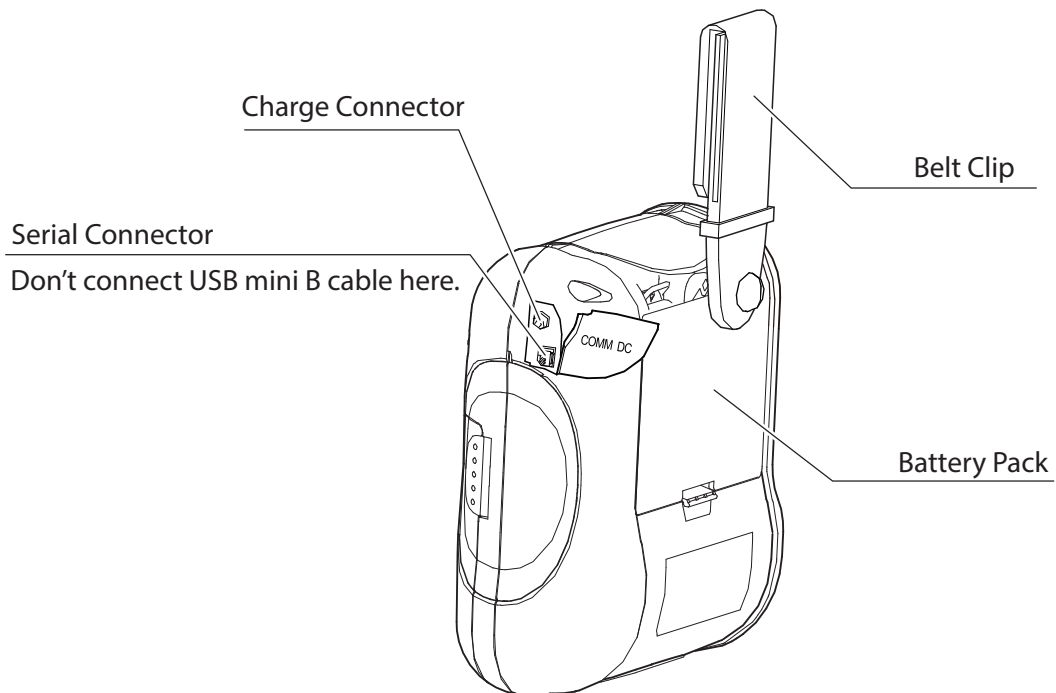

2. Setup

2.1 Battery Pack

2.1.1 Inserting into the Printer or the Battery Holder

1. Make sure that the printer has been turned off before you insert or remove the battery pack.
2. Insert the battery pack into the back of the printer as in the figure shown below, following the direction of the arrow.

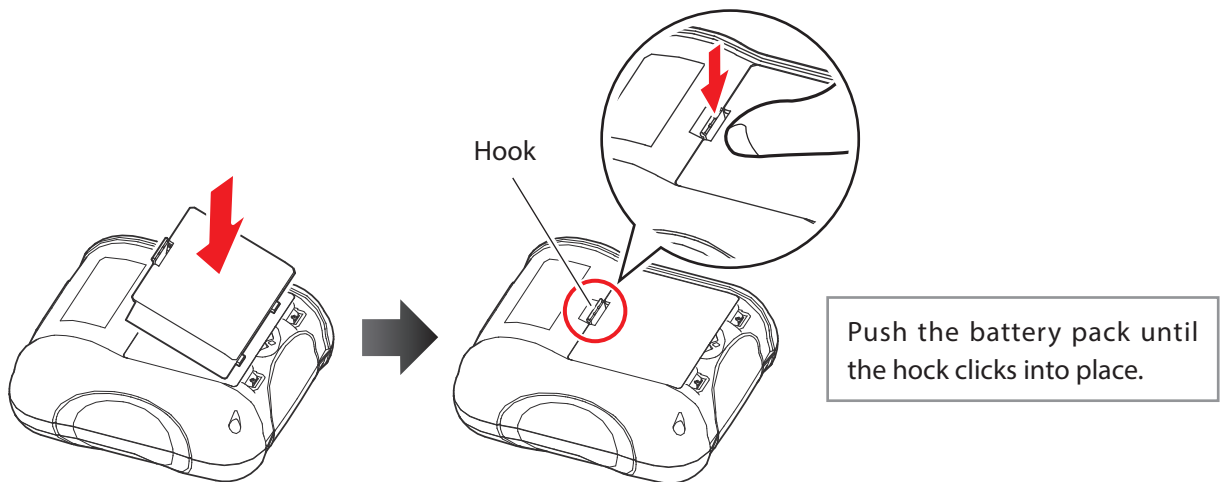

3. To remove the battery back, pull back the hook, and use the opposite procedure from the one you used to insert the battery pack.
4. The battery pack install into External Battery Cradle.
Insert the battery pack in the direction of the arrow.

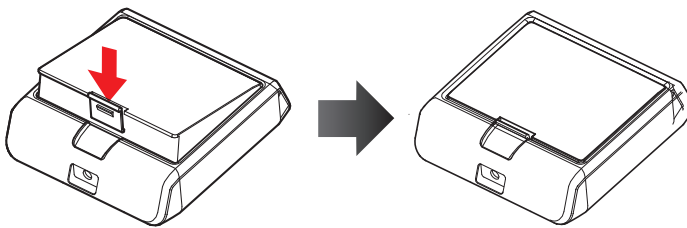

2.1.2 Charging the Battery

Insert the battery pack into the printer to charge it.

Insert the designated battery charger into the inlet of the printer or battery holder.

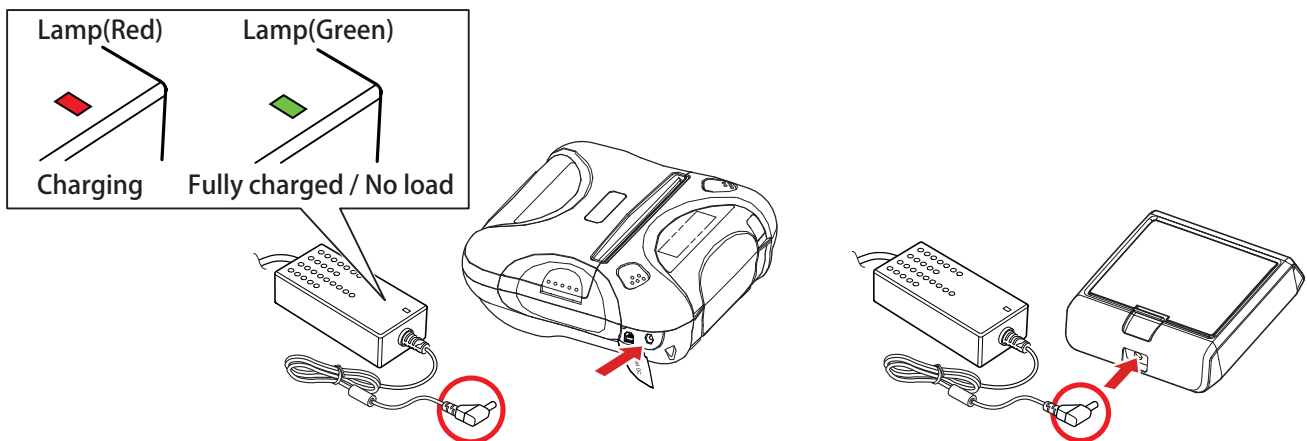

Note: When the battery charger is connected to the printer without the battery pack, the printer turns on but cannot print.

Notes about the Battery Pack

► General Battery Characteristics

- The battery is a consumable and its performance over time will gradually decrease.
- While not in use, the battery will slowly discharge itself.
Prepare a battery pack that has been charged relatively recently (1 to 2 days earlier).
- To ensure that the battery lasts for a long time, we recommend that you turn off the printer whenever possible.
- When used at low temperatures, battery performance will temporarily decline. Be sure to have a fully-charged spare battery standing by if the printer will operate in a cold environment.

► Charging the Battery Pack

- The battery pack can be charged at ambient temperatures between 0 and 40°C.
- The time required to charge the battery pack varies depending on the voltage and the ambient temperature.
Normally, it takes 4 to 5 hours to charge the battery pack.
- Turn off the printer power while the printer is charging.
- Printing while the printer is charging will shorten the battery lifetime.
- Do not remove the battery pack while it is being charged.
- Fully charge the battery prior to using the printer. Otherwise, the performance of the battery may be affected.
- There is no need to completely discharge or use up a rechargeable lithium ion battery before re-charging it.
- It is normal for the battery pack to be hot after it has finished charging or been used.
- Do not frequently repeat charging when there is still sufficient remaining battery charge.

► **Battery Pack Life**

- The battery can be charged approximately 300 times in the normal temperature range without losing performance. If an extreme decline in the running time of the battery is noticed, the battery is reaching the end of its usable life. It is recommended to replace the old battery with a new one.

► **Notes about Using the Battery Pack**

- Only use a designated battery pack. There is a risk of explosion or fire.
- Only use the designated battery charging method. There is a risk of explosion or fire. (You cannot use a battery charger other than the designated battery charger.)
- Do not throw the battery pack into a fire, place it near a flame or heating device, or use, charge or leave it in a hot environment (under direct sunlight, in a car, etc.). There is a risk of heat generation, smoke emission, explosion, fire, or battery acid leakage.
- Do not use a battery pack that has been dropped or subjected to a shock in some other way. There is a risk of heat generation, smoke emission, explosion, fire, or battery acid leakage.
- Do not disassemble or modify the battery pack. Doing so could lead to injury, fire, or electric shock.
- Do not short the terminals of the battery pack or get it wet. Do not put the battery pack in a bag with a metal object such as a key. There is a risk of heat generation, smoke emission, explosion, fire, or battery acid leakage.
- If the battery acid gets into contact with the eyes, wash eyes immediately with water and consult a doctor. Leaving your eyes untreated could result in blindness.
- If there is an abnormality such as heat generation, smoke emission, explosion, fire, or battery acid leakage while the battery pack is being used or stored, remove the battery pack from the printer immediately. Consult your dealer.

► **Notes about Storing the Battery Pack**

- The characteristics of the battery pack may degrade if you store it in a charged state for a long period of time. If you do not intend to use the battery pack for a while, charge it to approximately 50 %, and then remove it from the printer.
- If you do not intend to use the battery pack for a long time, be sure to remove it from the printer, and do not leave it connected to a battery pack holder for external charging.
- Keep the battery pack out of the reach of children. In addition, be careful that children do not remove the battery pack.
- Store the battery pack in a cool place.
 - * We recommend that you store the battery pack in a dry area with an ambient temperature of 15 to 25 oC.
 - * Avoid storing the battery in locations with high or extremely low temperatures.

! Make sure to follow the instructions below to prevent the battery from permanent damage.

- If you do not intend to use the battery pack for a long period of time, charge it to approximately 50 %, and then remove it from the printer.
- During storage, charge the battery pack to approximately 50 % every 3 months.
- When the remaining battery level is low, charge the battery as soon as possible.
- If the printer turns off due to insufficient battery remaining, make sure to recharge the battery within 15 days.

► Battery Disposal and Recycling

A lithium-ion battery is used to power this device. Since the disposal process of batteries varies from country to country, refer to the appropriate measures mandating the disposal method of the country in which this device is used.

< For U.S.A. and Canada >



Lithium-ion batteries are recyclable. You can help preserve our environment by returning your used rechargeable batteries to the collection and recycling location nearest you. For more information regarding recycling of rechargeable batteries, call toll free 1-800-822-8837, or visit <http://www.rbc.org/>

2.2 Bluetooth

2.2.1 Pairing

1. Press and hold POWER button for approx. 5 seconds, and printer is turned on. Then, it is ready to pair with another Bluetooth device.

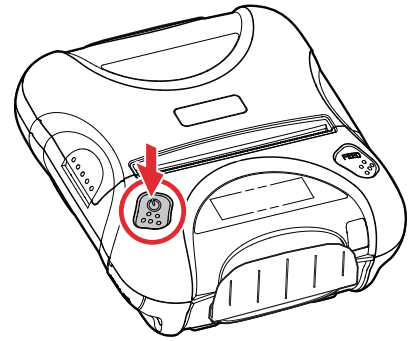

2. On the host device, tap [Settings]. Set [Bluetooth] to ON. Select "Star Micronics".

< Android >

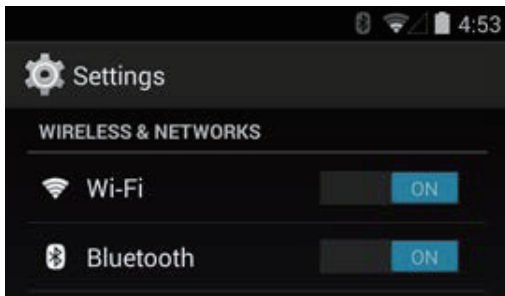

3. If necessary, enter the following information into the terminal that you are using.
PIN: 1234 (default)

CAUTION

- 1) *For security purposes, we recommend that you change the PIN. The following utility is required to change the PIN.
Please download and use the utility soft from the following URL.
iOS <https://www.star-m.jp/prjump/000003.html>
Android <https://www.star-m.jp/prjump/000004.html>
Windows <https://www.starmicronics.com/support/>
Or, please contact the seller.
For instructions on how to use this utility, please refer to the Bluetooth Setting Utility Software Manual.*
- 2) *If the quantity of data which is printed at once is more than 1M byte on Bluetooth communication, it would cause the buffer to overflow and the data to get damaged.*
- 3) *For instructions on how to connect with a host device, please refer to your host device user manual.*



You can test the connectivity with a host device by using StarIO SDK Application which is available on Google play.

2.3 Loading Paper

Refer to “4.2 Recommended Paper (Common thermal roll paper)” of Page 30), to select roll paper that conforms to the specifications.

1. Turn on the printer.
2. Put your finger on the switch for opening the cover, and then open and raise the printer cover.

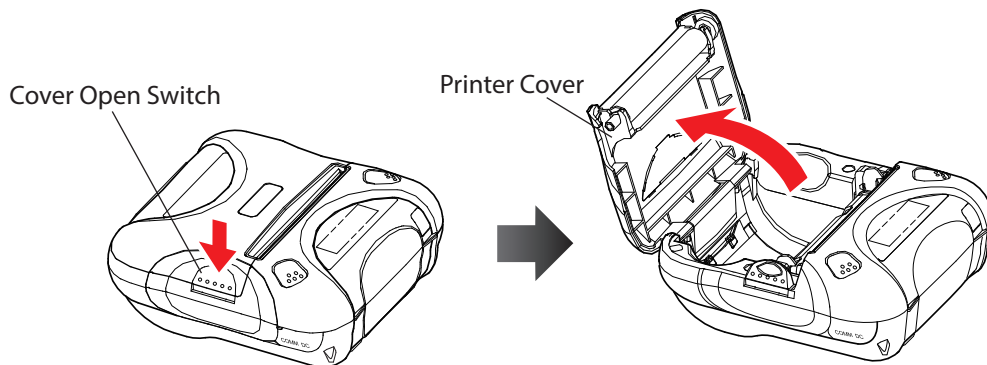

3. Load the roll paper in the orientation shown in the figure below, and then pull the end of the roll straight toward you.

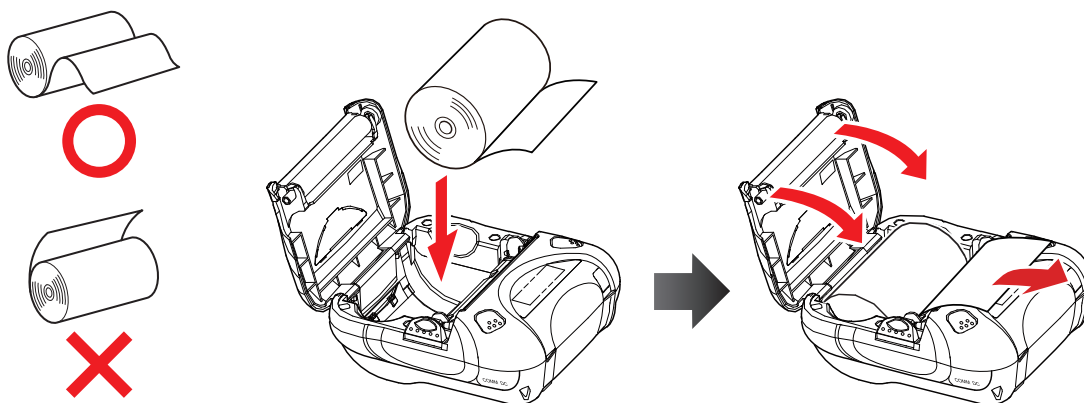

4. Press down on both sides of the printer cover to close it firmly.
When you close the printer cover, make sure that it is closed on both sides.
5. Use the tear bar to cut the extra paper.

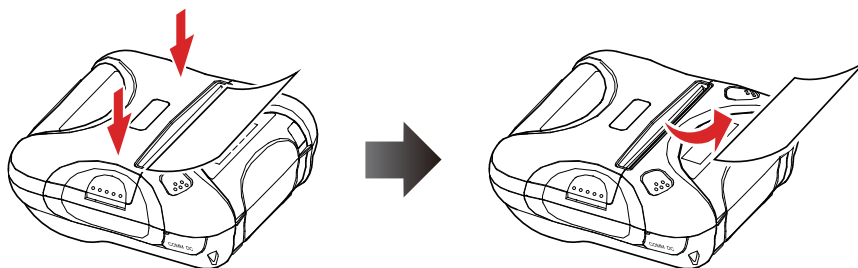

⚠ CAUTION

When the paper is jammed, be sure to open the printer cover before removing the jammed paper.

Do not under any circumstances try to pull out the jammed paper forcefully while the printer cover is closed. Doing so may damage parts of the printer.

! **WARNING**

1) Do not touch the tear bar.

- There is a tear bar inside the paper outlet slot. Not only should you not put your hand in the paper outlet slot while printing is in progress, never put your hand into the outlet even when printing is not in progress.**
- The paper cover can be opened when replacing the paper. However, since the tear bar is on the inside of the paper cover, be careful not to place your face or hands too close to the tear bar.**

2) During and immediately after printing, the area around the thermal head is very hot. Do not touch it, as you could be burned.

2.4 Belt Clip

2.4.1 Attaching to the Printer

Follow the procedure below to attach the belt clip to the printer.

1. Make sure that you are attaching the belt clip in the right orientation, then screw the screw that comes with the belt clip into the designated screw hole to attach the belt clip to the printer.
2. Use a coin to firmly screw in the screw.

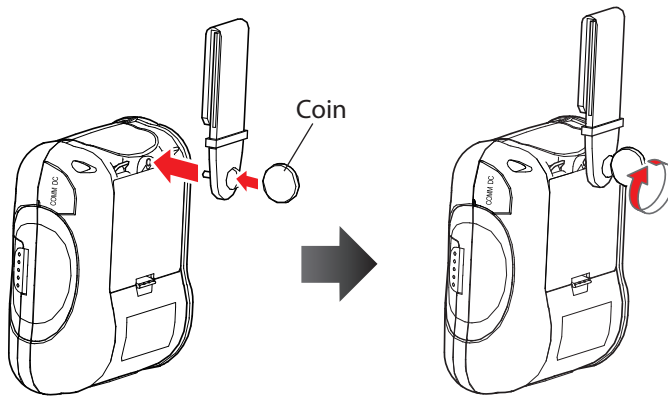

2.4.2 Using the Belt Clip

When the printer is attached to your belt, you can use it like the picture below.

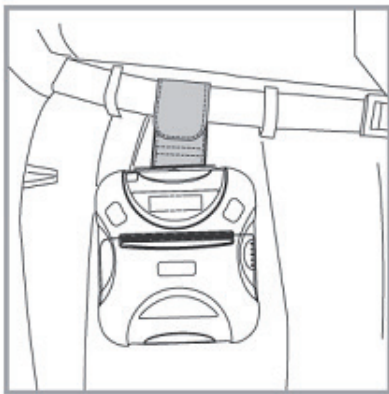

Hold the printer firmly with your hand when you swipe a magnetic stripe card or cut paper. If it is not held firmly, you may fail to read card data or cannot cut paper smoothly with the tear bar.

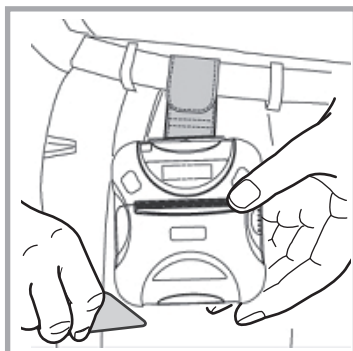

3. Printer Features

3.1 Control Panel

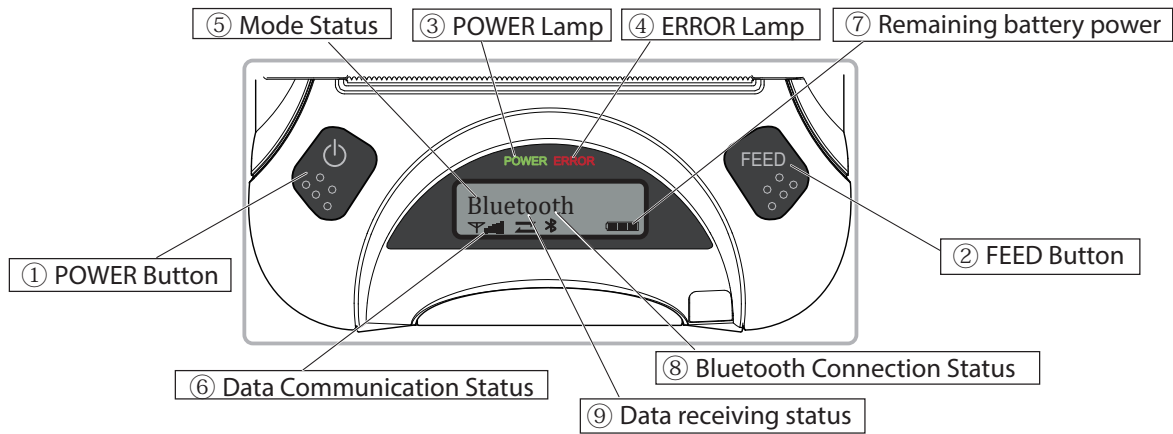

3.1.1 Button

- ① POWER Button :
Pressing and holding the POWER button for 5 seconds or more will turn the power on or off.
- ② FEED Button :
When the printer is on, pressing and holding the FEED button for 1 second or more feeds a paper.
- ◆ Pressing the ①POWER button and ②FEED button simultaneously enables you to change the printer mode setting. The buttons are also used to change the mode and change over the setting contents.(For more details on the mode setting, refer to "3.3. Memory Switch Setting".)

3.1.2 Panel Lamp

- ③ POWER (Green) : Printer is ON and ready to receive data.
Data receiving is possible when this lamp is turned on.
The lamp flashes while data receiving is in progress.
- ④ ERROR (Red) : Indicates an error has occurred.

3.1.3 LCD

- 1) The 128 × 32 dot display shows alphanumeric characters.
- 2) Content
 - ⑤ Mode/Status : Indicates the currently specified printer mode or error status.
 - ⑥ Data communication status : ... The image shown on the left indicates that the data communication status is good.
 - ⑦ Remaining battery power : ... There is sufficient remaining battery power.
 ... The remaining battery power is low. Please charge the battery pack. (*)
 ... The remaining battery power is extremely low. Stop using the printer immediately, and charge the battery pack. (*)
Note*)If you continue printing at the low remaining battery power status, the printer cannot feed paper properly and may print with condensed (narrow) line spacing.
 - ⑧ Bluetooth connection status : ... Only turns on when communication occurs during Bluetooth pairing.
 - ⑨ Data receiving status: ... Indicates that data receiving is in progress.

3.2 Self Test

You can use a self test to check the printer's settings.

Before you start the self test, make sure that roll paper has been properly loaded into the printer.

3.2.1 Self Test Procedure

1. Turn the printer power by holding down the FEED button and the POWER button simultaneously for 5 seconds or more.
2. The printer will print the current printer status, including the firmware version, communication mode, and print settings.
3. The self test will finish automatically. The printer will be ready to receive data after the self test finishes.

Note: If the firmware version is 4.0 less than, the "EMULATION" setting will not be printed by this self test procedure. Please use the instructions in section 3.2.2 to perform a self test.

3.2.2 Printing the Bluetooth Device Name and the Bluetooth Device Address

1. Follow the procedure in section 3.2.1 to start a self test.
2. Before the self test finishes, press and hold FEED button and MODE button at the same time.
3. The printer will print the Bluetooth device name and the Bluetooth device address (the contents up to the memory switch setting information in case of the StarLine mode), and the self test will finish automatically. The printer will be ready to receive data after the self test finishes.

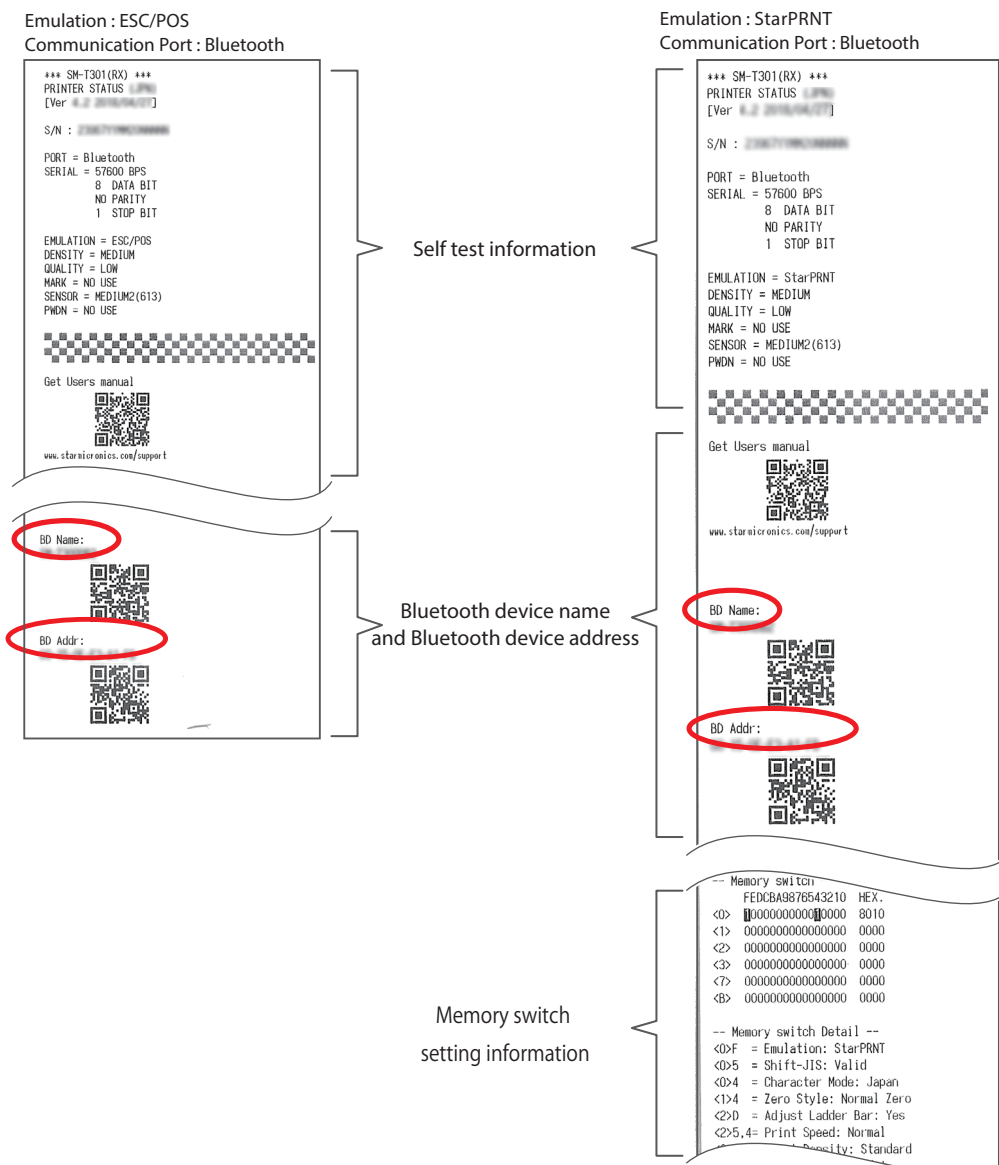

3.3 Memory Switch Setting (By the buttons on the printer.)

For details on the printer settings, refer to "[Setting Table]" of Page 25.

The setting change by memory switch is enable before shipment.

The setting change by memory switch is the following steps.

1. Turn on the printer power by pressing and holding down the FEED button and the POWER button simultaneously for 5 seconds or more. The printer will perform self printing.

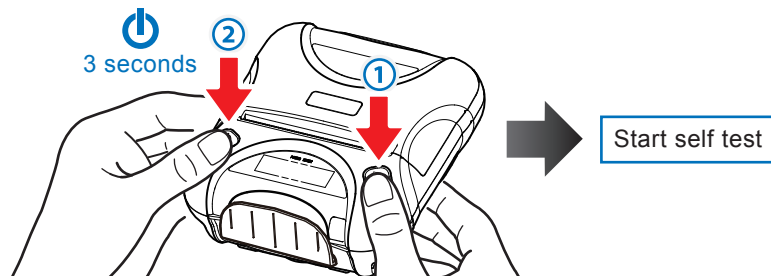

2. After the self test finishes, release the POWER button and the FEED button, and press the POWER and FEED buttons simultaneously within 2 seconds.
Hold down both buttons for 2 seconds or more and release the buttons.

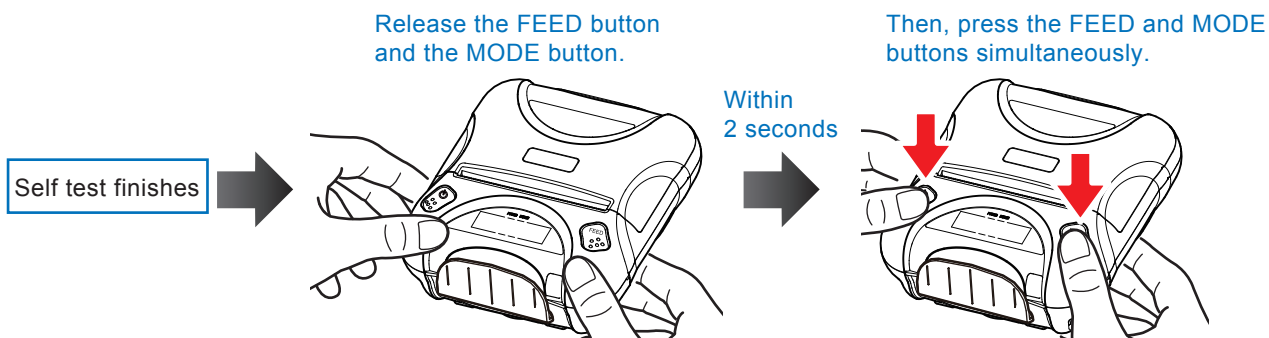

3. If the printer prints out "Memory SW setting = Disabled", the setting change by memory switch is enabled.

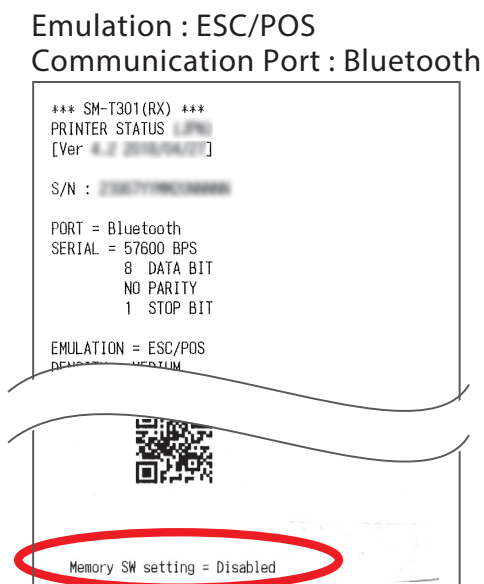

* When the above steps 1 to 4 are performed while the setting change by memory switch is disabled, the printer prints out "Memory SW setting = Enabled" and the setting change by memory switch is disabled.

Change the Memory switch by following operations.

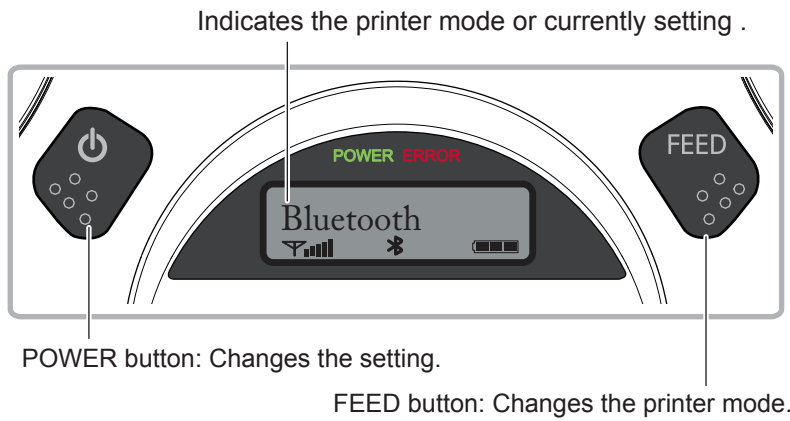

1. Press and hold POWER for approx. 3 seconds, and printer is turned on.

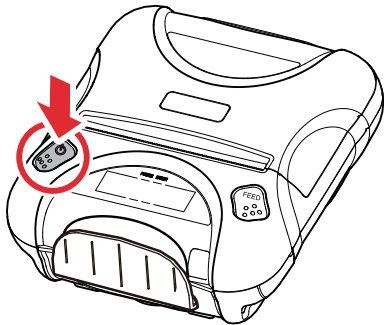

2. To put the printer into Memory Switch Setting mode, press and hold both the POWER & FEED buttons for 3 seconds. After the ERROR LED flashes five (5) times, you can configure the settings. Release the buttons after you surely confirm the LED flashes five (5) times, to get a printer into the setting mode.

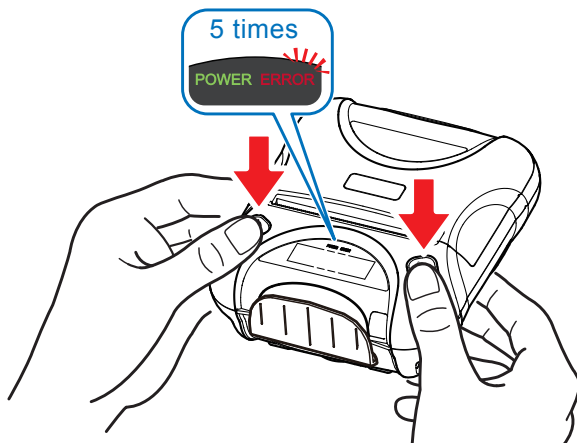

⚠ CAUTION

Before changing the memory switch settings, make sure that the communication with a host device is disconnected.

When the printer is under the Bluetooth communication with a host device, it cannot enter the Memory Switch Setting mode.

3. To switch the printer mode , press FEED button.
4. If the current printer mode does not need to be changed, press FEED button again and switch the printer mode. To change the setting, press POWER button.

*** Example:**

When you want to change the settings of the printer mode as shown below,

<Before> Bluetooth / 9600 BPS / 8 DATA BIT / NO PARITY / 1 STOP BIT / DENSITY LOW /
LOW QUALITY / MARK NO USE / SENSOR LOW / PWDN1min Sleep

<After> Bluetooth / 9600 BPS / 7 DATA BIT / EVEN PARITY / 1 STOP BIT / DENSITY LOW /
HIGH QUALITY / MARK NO USE / SENSOR HIGH / PWDN1min Sleep

- 1 Press and hold the POWER & FEED buttons for 3 seconds. After the ERROR LED flashes five times, you can configure the settings.
- 2 Press the FEED button once and then you can change the baud rate setting.
- 3 When the baud rate does not need to be changed, press the FEED button once again and you can change the data bit setting. Press the POWER button once and the data bit will change to "7 bit".
Display: 8 DATA BIT → 7 DATA BIT
- 4 Press the FEED button once and then you can change the baud rate setting.
Press the POWER button twice and the parity bit will be changed to "EVEN PARITY".
Display: NO PARITY → ODD PARITY → EVEN PARITY
- 5 Press the FEED button once and then you can change the stop bit setting.
When the stop bit does not need to be changed, press the FEED button once again and you can change the print density setting.
- 6 When the print density does not need to be changed, press the FEED button once again and you can change the print quality setting.
Display: LOW QUALITY → HIGH QUALITY

5. After you have configured all of the settings, press and release FEED and MODE at the same time. The new settings will be printed.

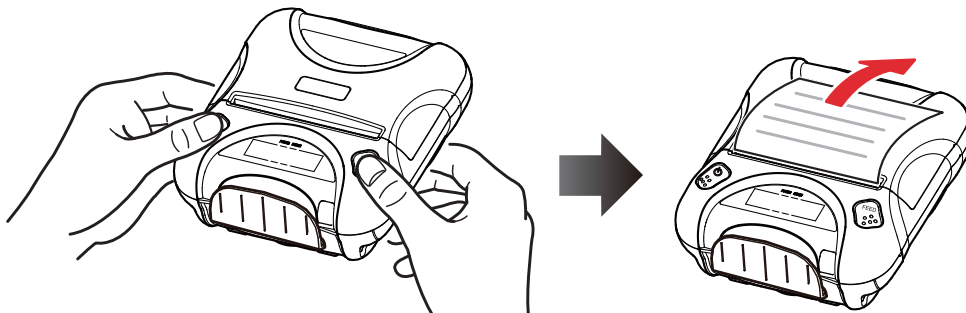

If the settings were not configured correctly, follow the above procedure to configure the settings again.

[Setting Table]

Note : *To change the memory switch setting of the table below, use the buttons on the printer or the StarPRNT Intelligence application that can be downloaded from our web site.*

	Printer Mode	Setting	Display
1	Communication Port *1)	RS-232C	UART Mode
		Bluetooth *	Bluetooth
2	Baud Rate	9600 bps	9600 BPS
		19200 bps	19200 BPS
		38400 bps	38400 BPS
		57600 bps *	57600 BPS
		115200 bps	115200 BPS
3	Data Bit	7 Data bit	7 DATA BIT
		8 Data bit *	8 DATA BIT
4	Parity Bit	No Parity *	NO PARITY
		Odd Parity	ODD PARITY
		Even Parity	EVEN PARITY
5	Stop Bit	1 Stop bit *	1 STOP BIT
		2 Stop bit	2 STOP BIT
6	Print Density	Density Low	DENSITY LOW
		Density Medium *	DENSITY MEDIUM
		Density High	DENSITY HIGH
7	Print Quality	Low (80mm/s) *	LOW QUALITY
		High (50mm/s)	HIGH QUALITY
8	Black Mark Sensor	No use *	MARK NO USE
		Use	MARK USE
9	Black Mark Sensor Sensitivity	Low *	SENSOR LOW
		Medium 1	SENSOR MEDIUM1
		Medium 2	SENSOR MEDIUM2
		High	SENSOR HIGH
10	Power Down	No use *	PWDN NO USE
		1 Minute Sleep	PWDN 1 mim Slp
		2 Minute Sleep	PWDN 2 mim Slp
		3 Minute Sleep	PWDN 3 mim Slp
		4 Minute Sleep	PWDN 4 mim SIP
		5 Minute Sleep	PWDN 5 mim Slp
		1 Minute Power Off	PWDN 1 mim Off
		2 Minute Power Off	PWDN 2 mim Off
		3 Minute Power Off	PWDN 3 mim Off
		4 Minute Power Off	PWDN 4 mim Off
5 Minute Power Off	PWDN 5 mim Off		

*: Default

Refer to the next page for *1.

❖1) Communication mode

It is possible to change the communication mode setting between Bluetooth and serial. Please see below for details to select the proper communication mode for your application.

RS-232C:

[RS232C] is printed when a self test is executed. At the RS-232C mode, the printer can communicate with a device using the serial communication cable supplied with the printer. When you connect the serial cable, the printer is automatically switched to serial communication from Bluetooth communication.

Bluetooth:

[Bluetooth] is printed when a self test is executed.

At the Bluetooth mode, the printer can communicate with Mac, Android device and Windows over Bluetooth.

◆ Simple method of switching over between ESC/POS and StarPRNT emulation modes

1. Turn the printer power and open the printer cover.

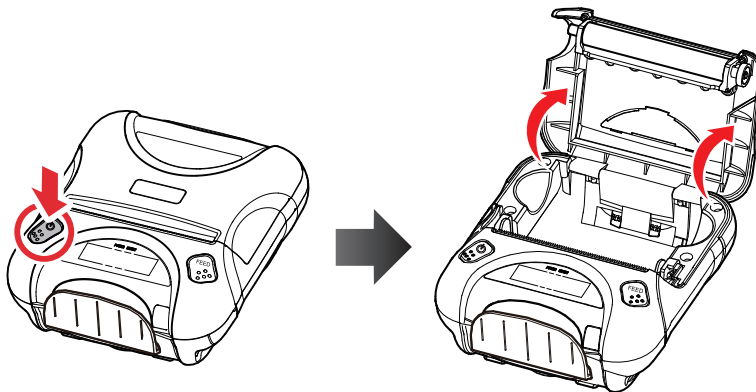

2. Press and hold the MODE button and the FEED button simultaneously. As soon as the ERROR lamp flashes five times, release the buttons. The emulation switchover takes place automatically.

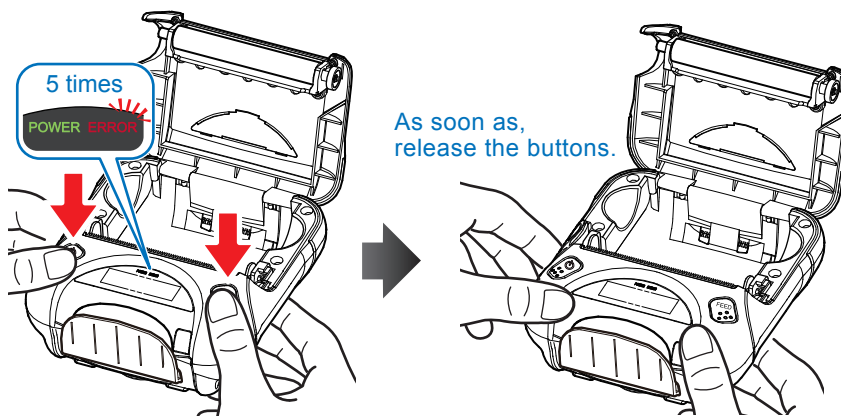

3. After setting a paper, close the printer cover. The set emulation mode is printed out.

ESC/POS mode: EMU = ESC/POS

StarPRNT mode: EMU = StarPRNT

If the emulation mode is not switched correctly, repeat the above steps 1 to 3.

At that time, in step 2, make sure not to release the buttons until the lamp completes the 5th flash.

4. Please reboot the printer after switching the emulation between StarPRNT and ESC/POS.

*It will be valid after rebooting the printer.

◆ Initialization of memory switch setting (factory setting)

To initialize the memory switch setting that has been changed, follow the steps below.

1. Turn the printer power and open the printer cover.
2. Press and hold the POWER button and the FEED button simultaneously and allow the ERROR lamp to flash five times. Continuously hold the buttons until the buzzer sounds five times. The POWER lamp and the ERROR lamp flash and the memory switch is initialized to the factory setting.

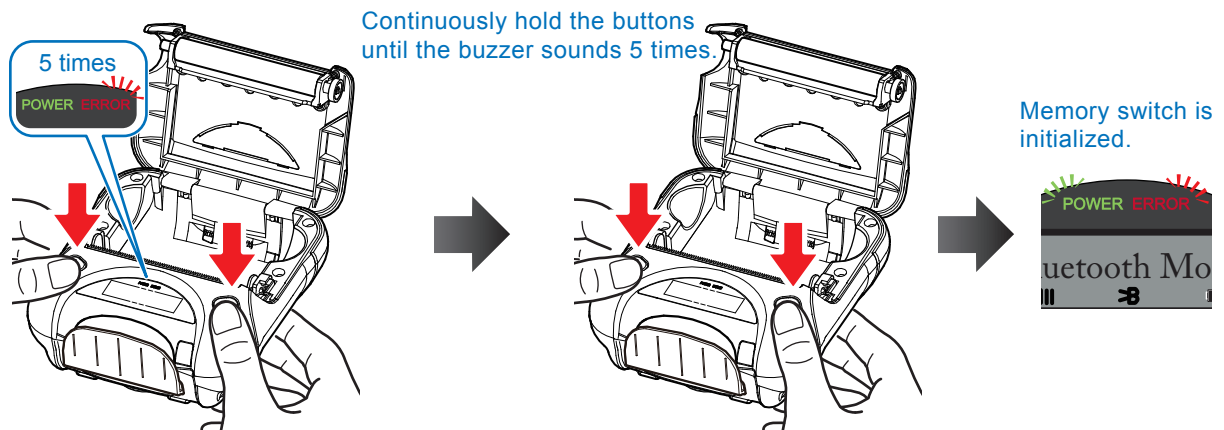

3. Set a paper and close the printer cover. The printer prints out "Memory SW was initialized."

3.4 HEX Dump Mode

All data sent from a host device is printed by hexadecimal codes.

This mode can be used to check if a program to be sent to the printer is coded correctly.

⚠ CAUTION

HEX dump mode cannot be used while status is being acquired from the application.

Follow the steps below.

1. While the printer cover is open, turn on the printer power by pressing and holding the FEED button and the MODE button simultaneously for five seconds or more.

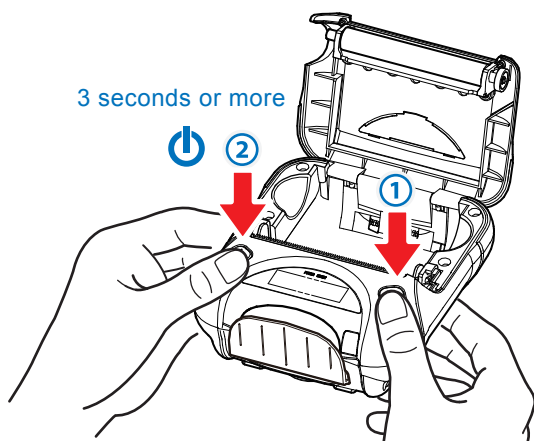

2. After the POWER lamp and ERROR lamp flash alternately, the buzzer sounds and only the ERROR lamp flashes continuously. Then, release the buttons and immediately press and hold the MODE button and the FEED button for three seconds or more, and release the buttons.

POWER lamp and ERROR lamp flash alternately.



Buzzer sounds.



Only the ERROR lamp flashes continuously.



As soon as the ERROR lamp flashes, release the buttons.

Immediately press and hold the both buttons for 3 seconds or more.

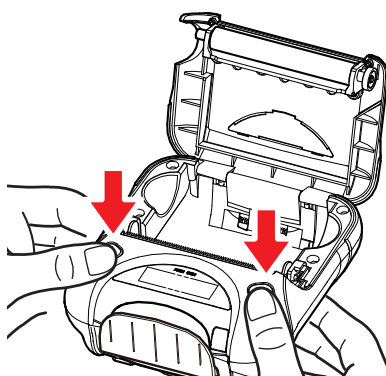
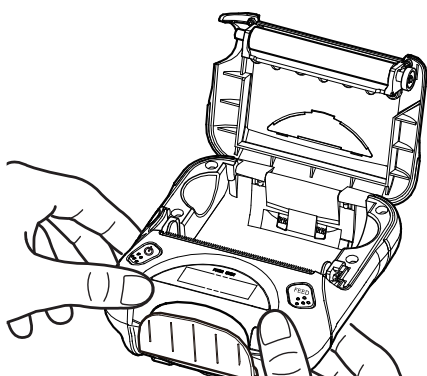

3. Set a paper and close the printer cover. The printer prints out "*** Hex Dump Printing ***" and enters the HEX dump mode.
4. To exit the HEX dump mode, turn off the printer power.

3.5 Instruction for Auto Power Down(Sleep) Mode

The printer in the Power Down(Sleep) Mode will recover to the Print Ready Mode when receiving datas or button operations.

However, print data received while shifting from the Sleep Mode to the print Ready Mode (for approx. 1 sec.) is discarded and cannot be printed.

Therefore, if the printer is in the Sleep Mode, please be sure to recover it to the Print Ready Mode before sending print data.

[How to Recover to Print Ready Mode & How to Check]

- 1) Send the Status command (DLE EOT EOT) and try to resend it until the printer receives the returned status value (any value from 30H to 37H). (*1)

Or

- 2) Press the FEED button or the MODE button (the Power button for SM-T300 series) and confirm that the Power lamp (Green LED) is turned on.

(*1: When the status value is not returned in the above 1) method, it is possible that the printer is turned off by the Power OFF mode. In this case, turn the printer on manually.

3.6 Card Reading (Only for Model with Card Reader)

Please keep the following points in mind when reading a card.

- Swipe the card with its magnetic stripe side towards the printer.
- Hold the card in the center as illustrated below and swipe it straight at a steady speed in the directions of arrows. You can swipe the card in either direction to read the data.

Be sure to hold the printer firmly with your hand while swiping.

If you hold the corner of the card, it is difficult to swipe it straight so that you may fail to read the card data. So hold the card in the center when you swipe the card.

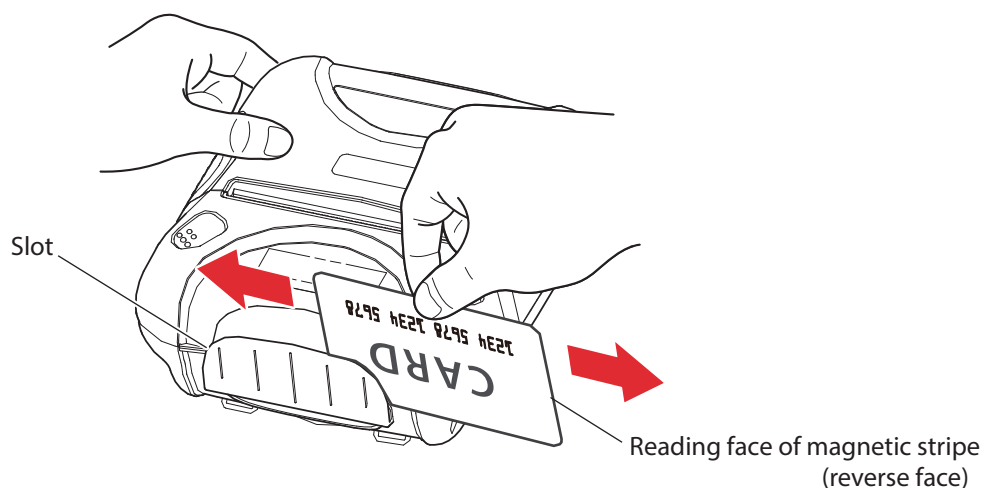

- A buzzer will sound once when a card is successfully read. When the printer fails to read the card, the buzzer will sound three times. Check the orientation of the card, and slide it through the reader slot again.

4. Paper

4.1 Paper Specifications

Type :	Thermal Paper
Paper width :	79.5±0.5 mm
Paper thickness :	61 to 75±5 μm
Outer diameter :	Ø50 mm or less
Core shaft inner diameter :	Ø12 mm or more
Core shaft outer diameter :	Ø18 mm or more
Recording side :	Outside of roll

4.2 Recommended Paper (Common thermal roll paper)

Manufacturer	Product Name	Paper thickness
Mitsubishi Paper Mills Limited	P220AG	65 μm
Oji Paper Co., Ltd.	PD450	65 μm
	PD160R	75 μm
	PD160R-63	63 μm
Domtar (Appvion)	Domtar POS 55H-2.4 (Alpha 800-2.4)	61 μm

4.3 Printing Range

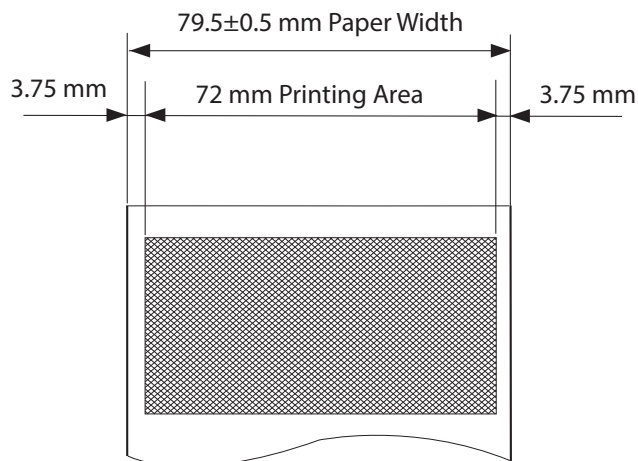

⚠ CAUTION

- 1) Do not use roll paper whose end is glued to its core, because the printer will be unable to properly detect the end of the paper. Also, we recommend that you use roll paper that has a roll end mark at its end.
- 2) Chemicals and oil may cause the roll paper to change color or cause the printed characters to become lighter.
- 3) The roll paper starts changing color at approximately 70°C.
Please be aware that the roll paper can be affected by heat, humidity, and direct sunlight.
- 4) The roll paper may change color if you scratch it with your fingernail, a hard piece of metal, etc.

5. General Specifications

Item	Specifications		
Printing method	Direct line thermal printing		
Characters per line	Maximum 64 cpl		
Character size	Alphanumeric characters: 9 X 24 dots, 12 X 24 dots, and 9 X 17 dots Japanese characters: 24 X 24 dots		
Character types	Alphanumeric characters, expanded graphic characters, JIS Level-1 Kanji Set, JIS Level-2 Kanji Set, and special characters		
Dot density	203 dpi (8 dots/mm)		
Printing width	72mm, 576 dots		
Print speed	80 mm/s (max)		
Interface	Bluetooth	Bluetooth Spec.	Bluetooth 3.0 / Class 2 (10 m)
		Frequency Range	2.4 GHz ISM BAND
		Support Profile	SPP (Serial Port Profile)
	RS-232C		
Emulation	ESC/POS, Firmware version 3.1 or later : StarPRNT		
Roll paper	Thermal roll paper (80 mm wide with a diameter of Φ 50 mm)		
Barcode	1D: JAN, EAN, UPC, ITF, Code39, Code93, Code128, CODABAR(NW-7), GS1 Barcode(StarPRNT only) 2D: PDF417, QR Code, DATA Matrix(ESC/POS only), GS1 2Dcode(StarPRNT only), GS1 Composite(StarPRNT only)		
Receive buffer size	1M bytes *1)		
MSR	SM-T300 : Not Supported MSR SM-T301 : ISO 7810 / 7811 / 7812 1st and 2nd Track Reading		
LCD	128x32 Dots FSTN (Blue LED Backlight)		
Battery pack	Rechargeable 7.4V DC 1800mAh		
Battery operating time	Approximately 26 hour printing (12 receipts per hour) Approximately 31 hour printing (12 receipts per hour / Sleep setting after 1 minute)		
Battery charger	Input: 100 to 250 V AC, 50 to 60 Hz Output: 8.4 VDC/0.8 A, Time required for full charge: 4 h		
Environmental Requirements	During charging	Temperature : 0 °C to +40 °C	
	During operation *2)	Temperature : -10 °C to +50 °C Humidity : 30% to 80% (No condensation)	
	During storage	Printer Temperature : -20 °C to +70 °C Humidity : 10% to 90% (No condensation) Battery pack Temperature : -20 °C to +50 °C (1month) -20 °C to +40 °C (3month) -20 °C to +20 °C (1year)	
Print head life	Approximately 50 km		
Drop resistance	1.5 m / 1.2 m (Model with Card Reader) *3)		
Dust protected, Splash proof	IP54 Certified *3)		

*1) If the quantity of data which is printed at once is more than 1M byte on Bluetooth communication, it would cause the buffer to overflow and the data to get damaged.

*2) Under 0°C, please change Density mode and Quality mode of the memory switch settings to both "High".
If you want to print a delicate pattern like Barcode printing, please use the printer over 0°C.

*3) Our test procedure, Not guarantee.

■ Dimensions

External Dimensions : 120 mm (W) × 130.5 mm (D) × 58.4 mm (H) <Model without Card Reader>
120 mm (W) × 132.5 mm (D) × 58.4 mm (H) <Model with Card Reader>

Weight * : 424 g (Including Battery Pack) <Model without Card Reader>
429 g (Including Battery Pack) <Model with Card Reader>
* Roll paper weight is not included.

Body Color : Gray

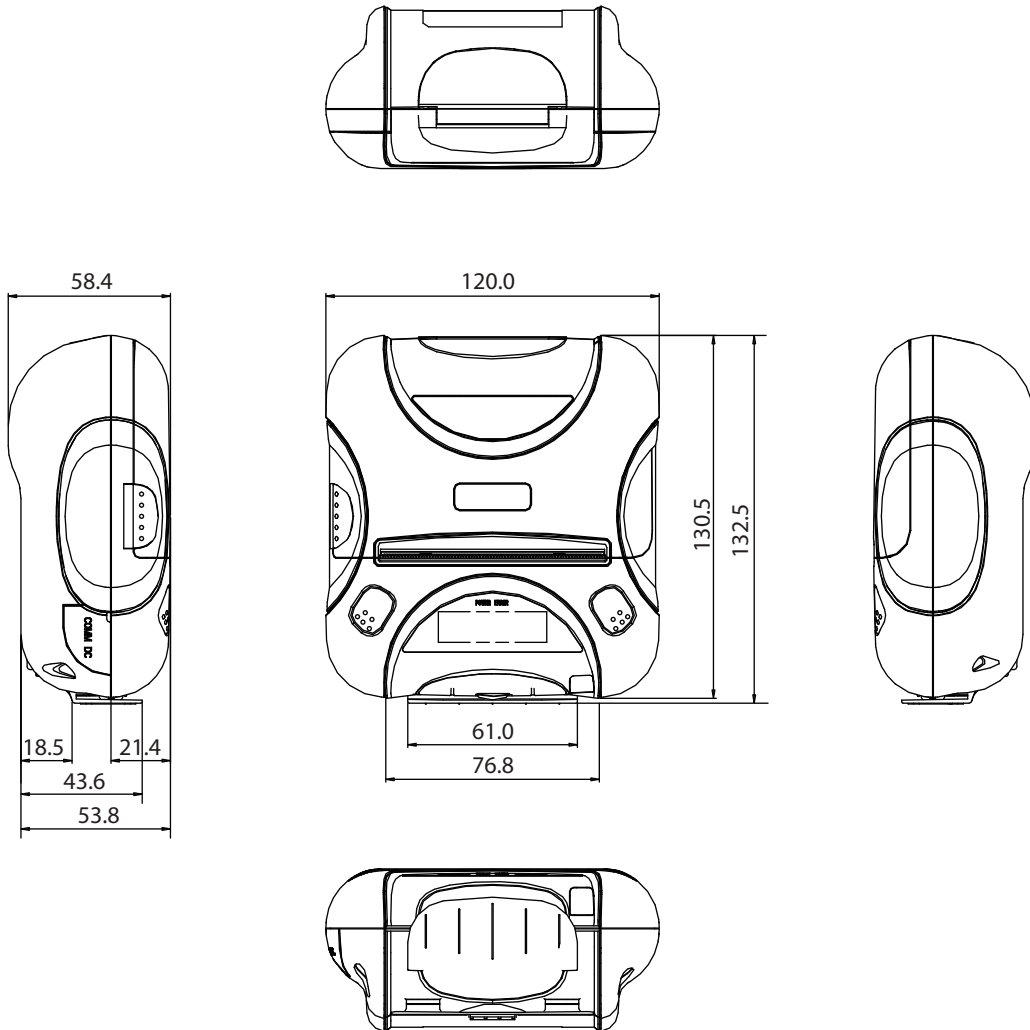

6. Version History

Version	Date	Update
Rev. 1.0	2016.09.02	New Release (StarPRNT supported / Bluetooth module changed)
Rev. 1.1	2017.05.31	Accessory changed, Safety Approvals changed
Rev. 1.2	2018.11.30	LED flashing specification changed
Rev. 1.3	2019.09.13	Added country names to Fitting regulation
Rev. 1.4	2020.02.19	Changed Battery Charger Specification
Rev. 1.5	2021.11.11	Update URLs which links to CE Doc, UK Doc and FCC IC statement
Rev. 1.6	2023.02.28	Changed the operating temperature, battery pack life, fitting regulation. Added the printer storage temperature.



URL: <https://www.starmicronics.com/support/>